

PROVIDING SAFETY

WE PROTECT YOUR
most valuable asset
YOUR WORKFORCE



T +31 (0)10 822 44 00
www.usp-safety.com

HOKUYO

PL d Category3 | SIL 2 Type3

Safety Laser Scanner UAM-05LP-T301

The Smallest Size in the World
with a Versatile Range for
Safety Applications

Actual
Size



“Small and light!”



Compact and Easy to Use

The compact design for installation on AGVs, AGCs as well as in vertical guarding applications.

Size | Height 95.0× Width 80.0× Length 80.0 mm

Weight | 0.8 kg

Conformity Standards

IEC61496-1/3	Type3
IEC61508	SIL 2
ISO13849-1	PL d Category3
UL508	
UL1998	
UL61496-1	Type3
CSA C22.2	No. 14



Collision Prevention

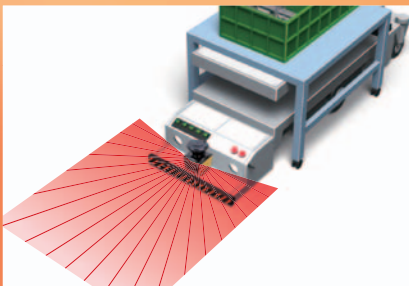

32 area patterns to accommodate the AGV travel path for collision prevention.

Presence Detection

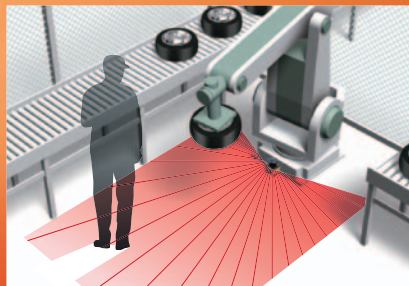

Detects humans or object entering the hazardous area.

Intrusion Detection



Detects access into critical zone. Reference boundary monitoring feature improves the safety by detecting the gaps around the protection zone and sensor's misalignment.

Expands The Range of Safety Applications

Protection over a Wide Range

Up to 5 meters of protection zone and 20 meters of warning zone configuration to suit various application requirement.



Data Output via Ethernet

Measurement data can be acquired via Ethernet with status of input/output signals and cyclic redundancy check code. Also supports command in SCIP2.0 protocol.

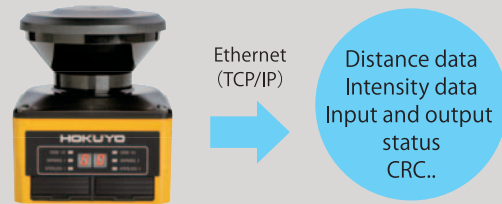

SD card for Configuration

Configuration data can be saved in a SD card which in turn can be used for configuring the UAM without connecting it to a PC. The feature is useful while replacing the UAM or configuring multiple units with the same settings.



Master-Slave Function

Maximum 4 units of UAM can be interconnected for Master-Slave operation when multiple units are required to guard the hazardous area. The system can be controlled by connecting the input and output signals to Master unit only.

Important Note: It is not possible to control the actuators via master-slave bus communication.

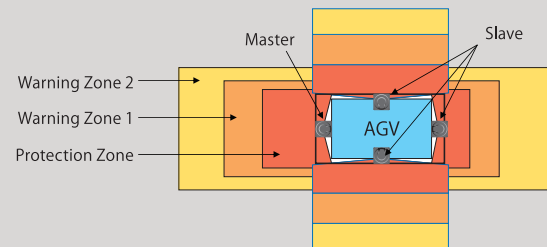

Encoder Input

In AGV applications, area is switched depending on the vehicle's speed. Speed and direction of travel provided via encoders are constantly monitored to switch the area and stop the AVG during abnormal travel.

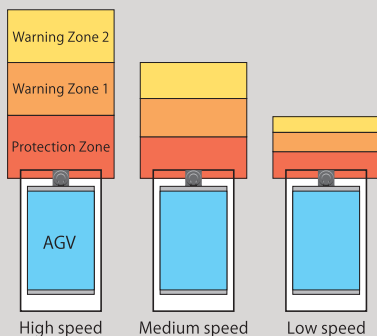

Dual Protection Mode

UAM can simultaneously protect two hazardous areas. Separate OSSD signals are triggered for the respective protection zones making it possible to guard two machines with a single UAM.

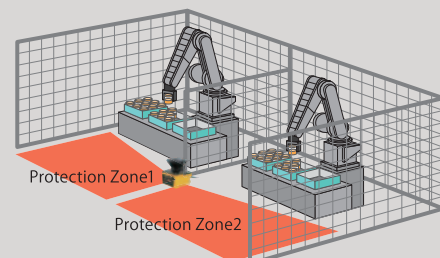

Easy Configuration of Complicated Zones

User Friendly Interface

Simple user interface to configure even a complicated zone by simultaneously viewing the measurement data. Zones can be configured with 3 different methods.

Before settings

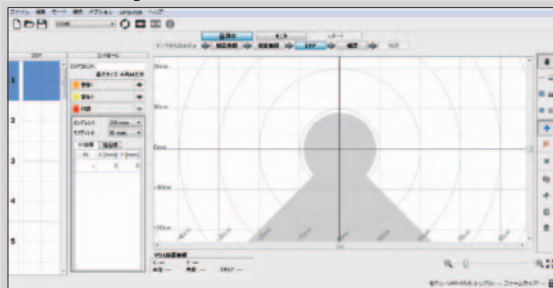

After settings

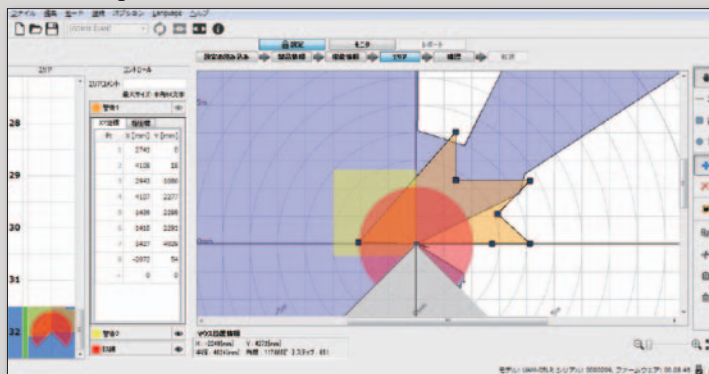

Category

Main unit

Appearance	Model number	Product code	Notes
	UAM-05LP-T301	UUAM005	CD-ROM consists of the configurator software and manual

Extension cable (Option)

Appearance	Specification	Model number	Product code	Notes
	Cable length: 10m	UAM-5C10	UZ00066	Bare cables
	Cable length: 20m	UAM-5C20	UZ00067	



USB cable (Option)

Appearance	Specification	Model number	Product code	Notes
	Micro USB Length: 1m	UAM-MUSB	UZ00065	For UAM configuration

Ethernet cable (Option)

Appearance	Specification	Model number	Product code	Notes
	Length: 3m	UAM-ENET	UZ00062	Ethernet cable is necessary for distance data output

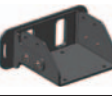
Brackets and optical window (Option)

Appearance	Specification	Model number	Product code	Notes
	Base mounting bracket	UAM-BK03	UZ00059	
	Rear mounting bracket	UAM-BK04	UZ00060	
	Cover bracket	UAM-BK05	UZ00061	To protect the optical window
	Optical window	UAM-W002	UZ00064	For replacement when damaged and only to be fitted by approved personnel.

UAM Configurator (Option)

Appearance	Specification	Model number	Product code	Notes
	CD-ROM	UAM-CD03	UZ00063	UAM Configurator for functions and zone configuration

Specification

Subject		Specifications
Model		UAM-05LP-T301
Detection property	Protection Range	Max : 5m
	Warning Range	Max : 20m (Non-safety) *1
	Distance Tolerance *2	+100mm
	Detection Capability	From Black-Reflector Sheet (1.8%) to Retro-Reflector Sheet
	Detection Range	270°
	Minimum Detectable Width	φ30mm (Max : 1.8m) φ50mm (Max : 3.0m) φ70mm (Max : 5.0m)
	Scan Frequency	30ms (Rotational Speed 2000rpm)
	Area Pattern	Max 32 patterns
Optics	Response Time	OFF 60ms~510ms ON 270ms~510ms
	Element	Pulsed Laser Diode
	Wave Length	905nm
	Safety Class	Laser Class 1
Type		Type 3 (IEC 61496-1, IEC 61496-3)
Functional Safety		SIL 2 (Type B, HFT=1) (IEC61508)
PFH _d		7.8×10 ⁻⁸ (T1=20 year) : When master slave function is not in use. 1.6×10 ⁻⁷ (T1=20 year) : When master slave function is in use.
Housing	Size	80.0mm (W), 80.0mm (D), 95.0mm (H) (without cable)
	Weight	0.8kg
	Protection	IP65
	Case Material	Body : Aluminum / Optical Window : Polycarbonate
	Connection Cable	Flying lead cable length : 3m
Power Supply		DC 24V ±10% : when operation using converter power supply DC 24V -30%/+20% : when operation using battery
Supply Current	Normal (without load)	6W
	Max. (with load)	50W
Output	OSSD1/2 (Safety)	Output type (High side SW) Output current (Max : 500 mA) *3 Leak current (Max : 1mA) AWG 26 Load tolerance (L/R=25ms, C=1μF)
	OSSD3/4 (Safety) WARNING 1/2 (Non-Safety)	Output type (High side SW) Output current : (Max : 250mA) *3 Leak current (Max : 1mA) AWG 28 Load tolerance (L/R=25ms, C=1μF)
	RES_REQ 1 RES_REQ 2 MUT_OUT 1 MUT_OUT 2	Output type (PNP Transistor) Output current : (Max : 200mA) *3 Leak current (Max : 1mA) AWG 28
Input	Area pattern 32 (5 Inputs x 2 Channels) EDM1/EDM2 MUTING1/MUTING2 MUTING3/MUTING4 OVERRIDE1 OVERRIDE2 RESET1/RESET2 ENC_A1/ENC_A2 ENC_B1/ENC_B2	Input Impedance 4.7 kΩ AWG 28
Interface	Configuration	USB2.0 (USB micro type-B connector)
	Data output	Ethernet 100BASE-TX (Water proof connector)
Environmental Resistance	Temperature	-10°C to +50°C (No freezing)
	Storage Temperature	-25°C to +70°C (No freezing)
	Humidity	95% RH with no condensation
	Storage Humidity	95% RH with no condensation
	Surrounding Intensity *4	Less than 1500lx
	Vibration	Frequency range : 10~55Hz Sweep rate : 1 octave/min Amplitude : 0.35mm ±0.05mm
Bump		Acceleration : 98m/s ² (10G) Pulse duration : 16ms
Outdoor Operation		Not permitted
Altitude		Below 2000m

*1. Distance when reflectance of the object is 90% or above.

*2. Additional distance of 200 mm is needed when the UAM is working under high reflective background.

*3. Total current supply of OSSD output and Warning output should be below 1.0A.

*4. When the light sources are located at ≥5° from the detection plane of UAM.

Wiring example

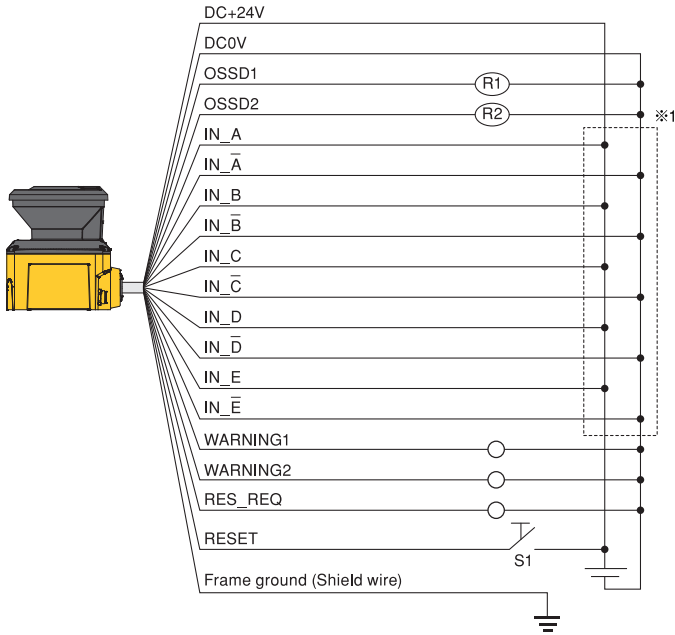

R1 and R2 : External equipment (Safety relay, Electromagnetic contactor)
S1: Interlock reset switch

*1: Refer to user's manual section 3.5 for details on area switching.

Color	Signal	Function	Description	AWG
Brown	+24V DC	Power	Power Supply : DC 24V	22
Blue	0V DC	Power	Power Supply : DC 0V	22
Red	OSSD1	Output	Protection area output 1	26
Yellow	OSSD2	Output	Protection area output 2	26
Red/Black	OSSD3/ WARNING1	Output	Protection area output 3/ Warning area output 1	28
Yellow/Black	OSSD4/ WARNING2	Output	Protection area output 4/ Warning area output 2	28
Purple	IN_A	Input	Area Switching Input A	28
Gray	IN_B/ MUTING3	Input	Area Switching Input B/ Muting input 3	28
White	IN_C/OVERRIDE1/ ENC1_A	Input	Area Switching Input C/Override input 1/Encoder input 1_A	28
Pink	IN_D/MUTING1/ ENC1_B	Input	Area Switching Input D/Muting input 1/Encoder input 1_B	28
Green	IN_E/EDM1	Input	Area Switching Input E/ External device monitoring 1	28
Purple/Black	IN_A-bar	Input	Area Switching Input A invert	28
Gray/Black	IN_B/ MUTING4	Input	Area Switching Input B invert/ Muting input 4	28
White/Black	IN_C/OVERRIDE2/ ENC2_A	Input	Area Switching Input C invert/ Override input 2/Encoder input 2_A	28
Pink/Black	IN_D/MUTING2/ ENC2_B	Input	Area Switching Input D invert/ Muting input 2/Encoder input 2_B	28
Green/Black	IN_E/EDM2	Input	Area Switching Input E invert External device monitoring 2	28
Yellow/Green	RESET1	Input	Reset input 1	28
Yellow/Blue	RESET2	Input	Reset input 2	28
Orange	RES_REQ1/ MUT_OUT1	Output	RES_REQ 1 : Request output 1 MUT_OUT 1 : Muting state output 1	28
Orange/Black	RES_REQ2/ MUT_OUT2	Output	RES_REQ 2 : Request output 2 MUT_OUT 2 : Muting state output 2	28
White/Blue(TP)	RS485+	Communication	Communication Protocol RS485	28
White/Red(TP)	RS485-	Communication	Communication Protocol RS485	28
Shield wire	FG	-	Frame ground	-

Input/Output circuit

OSSD output circuit

OSSD/Warning output is output type.

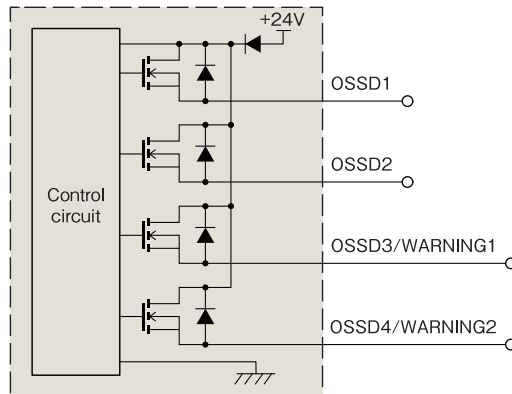

Other Output circuit

RES_REQ1, RES_REQ2, MUT_OUT1,
MUT_OUT2 output circuit.

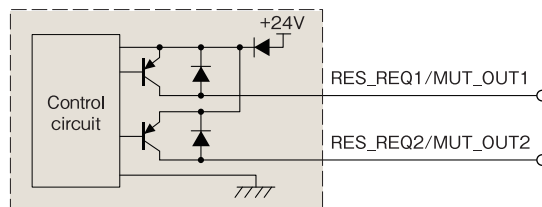

Input circuit

Area input, EDM1, EDM2, RESET1,
RESET2, MUTING1, MUTING2,
MUTING3, MUTING4, OVERRIDE1,
and OVERRIDE2

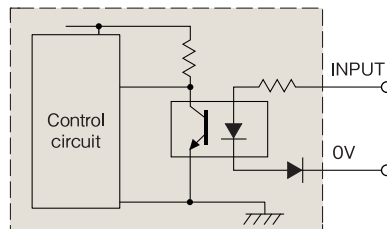

External Diagram

Sensor

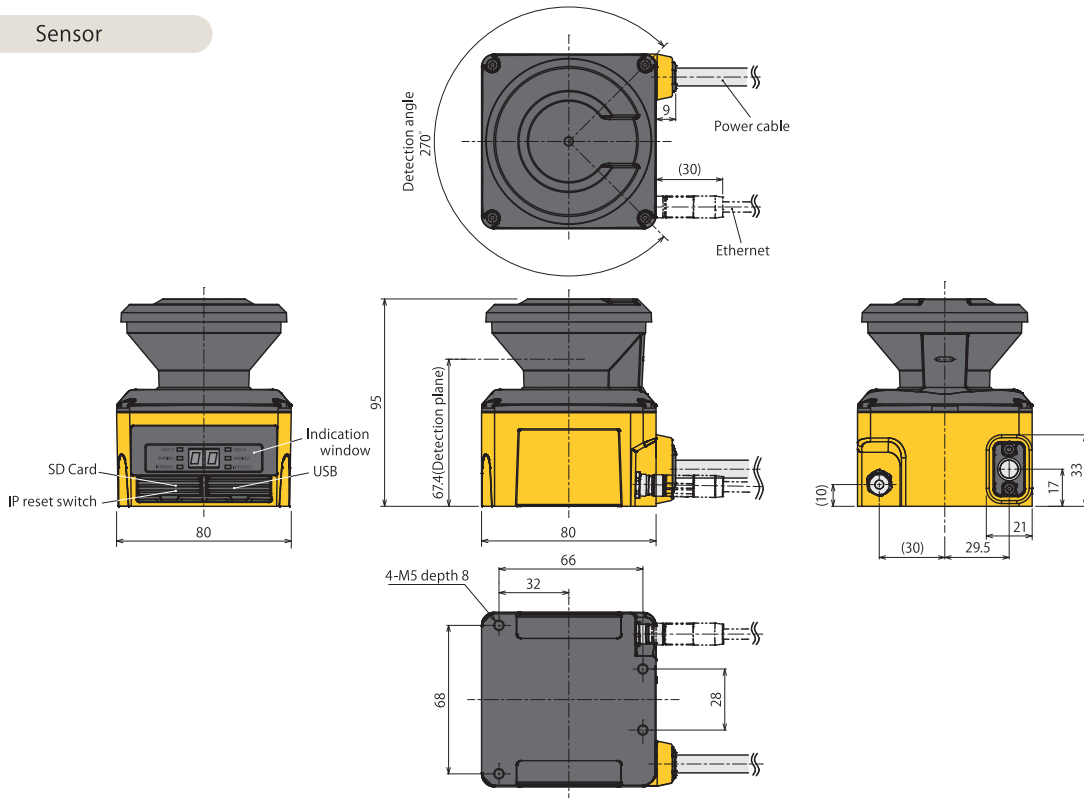

Fixed Condition of Rear mounting bracket with Cover bracket

Fixed Condition of Base mounting bracket with Cover bracket

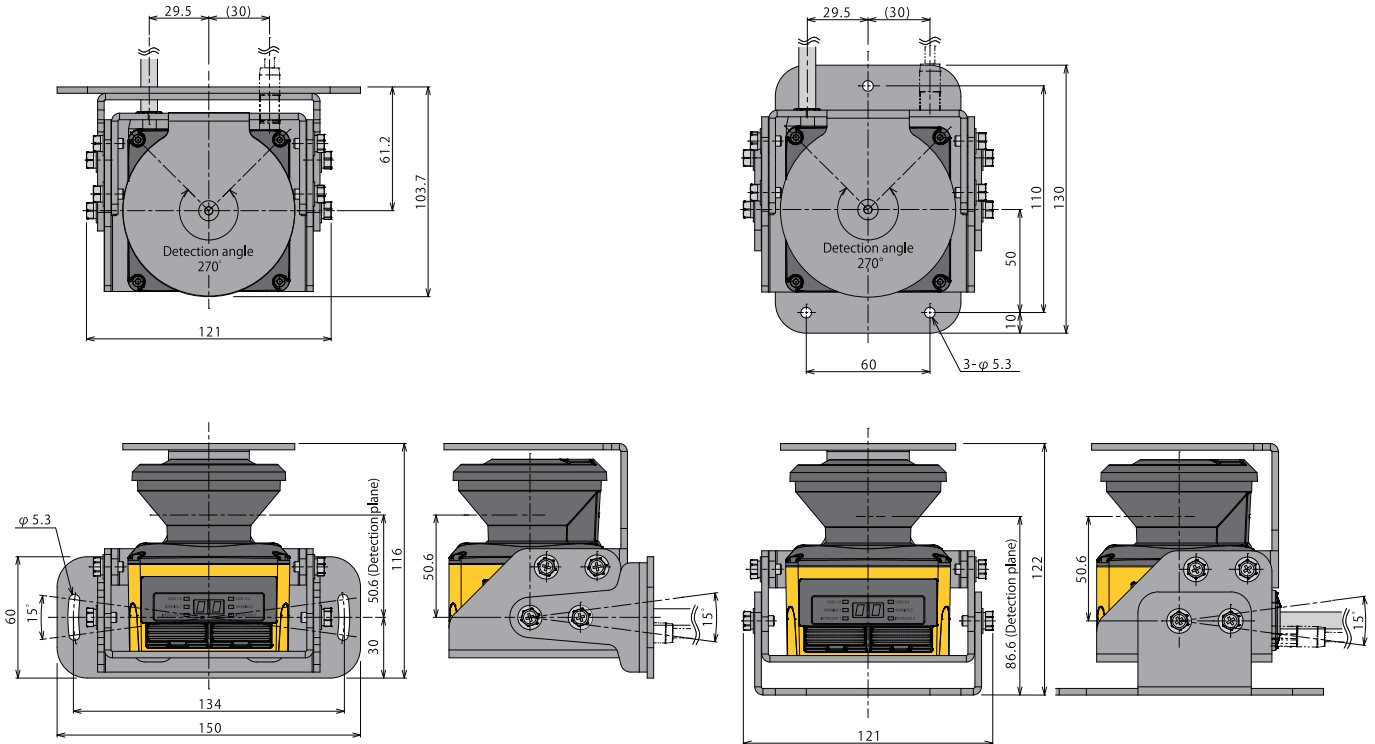

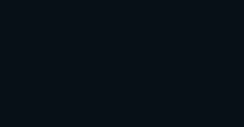

ISO14001 Certified
JQA-EM3873



ISO9001 Certified
JQA-1742



Caution for safety use

- Read instruction manual and brochure carefully before use.
- Products published in this brochure are intended to be used under certain conditions.
- For product related questions or technical issues, please contact our office.



HOKUYO AUTOMATIC CO.,LTD.

Osaka HU Building, 2-2-5 Tokiwamachi, Chuo-Ku,
Osaka, Japan. 540-0028

TEL: +81-6-6947-6333 FAX: +81-6-6947-6350

URL <http://www.hokuyo-aut.jp>

E-mail: info@hokuyo-aut.jp

- The contents of this catalog are based on material from October 2015. External dimensions and specifications may change without notice.