

PROVIDING SAFETY

WIR SCHÜTZEN
Ihr Wertvollstes Kapital
IHRE MITARBEITER



T +49 211 88231735
www.usp-safety.com



LBKSystem

The first safety barrier that works where optical sensors stop.



Immune to optical disturbances like smoke, dust, shavings, machining waste, splashes.



A perfect alignment between sensors is not required.



Configuration, e.g. the depth of the warning and danger areas, can be made quickly and easily through the provided PC application.



The system can detect the presence of humans and can give pre-alarms in order to avoid the sudden stop of the machinery.



The system detects which part of the dangerous area has been entered: different actions can be configured depending on the accessed zone.

LBKSystem

World's first SIL2/Pld radar system certified for safety-critical applications

The LBK System is an active protection radar system that monitors the dangerous areas of machinery. It performs two safety functions:

- **Detection Function:** it places the machinery in safe conditions when someone enters the dangerous area.
- **Restart Function:** it inhibits the restart of the machinery if there are operators in the dangerous area.

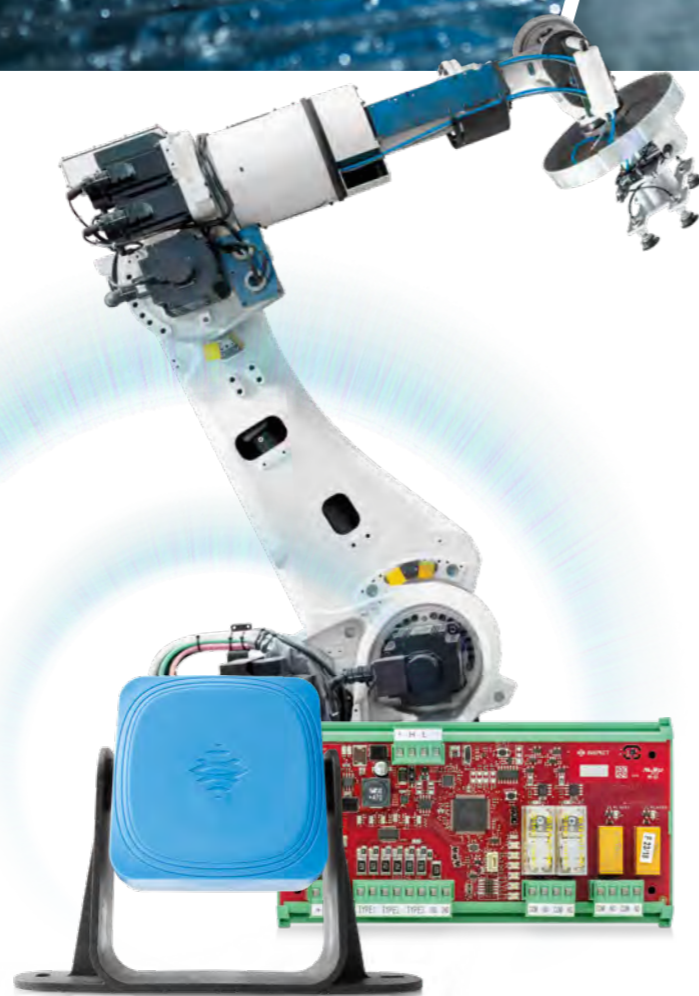

INXPECT SAFETY APPLICATION



The LBK System is composed of the **LBK-C22** control unit and up to six **LBK-S01** sensors. The **Inxpect Safety** software application allows the configuration and monitoring of the system, including the generation of the system configuration report and log download.

The maximum depth of the monitored area is 4m (13ft). With six sensors aligned and an inter-sensor distance of 2.5m (8.2ft), the system can cover an area 15m (49ft) wide.

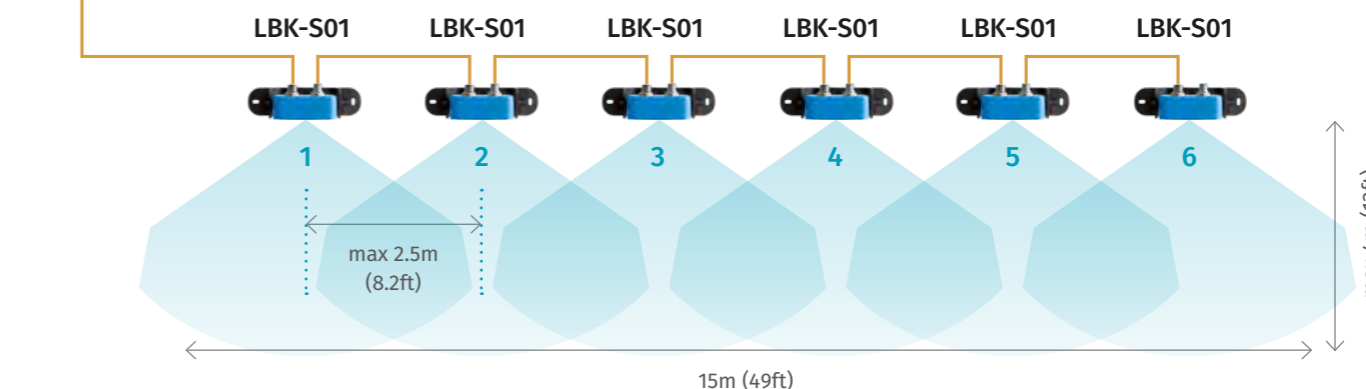

Sensor field of vision:

• **Horizontal plane:** 110°

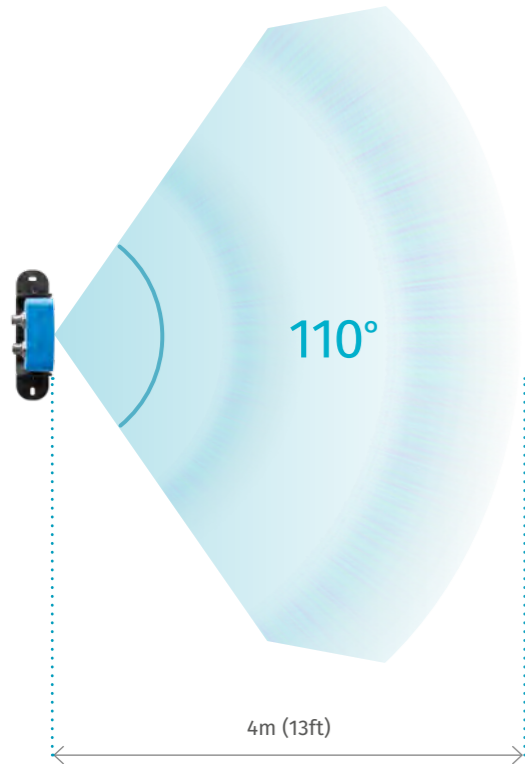

• **Vertical plane:** 30°

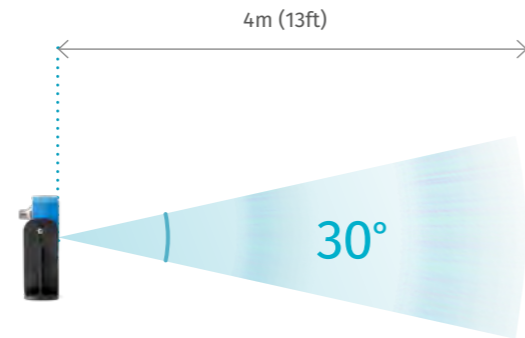

The actual field of vision of the sensor depends on:

- sensor height: from 0 to 1m (3.3ft)
- sensor tilt: from -20° to +20°

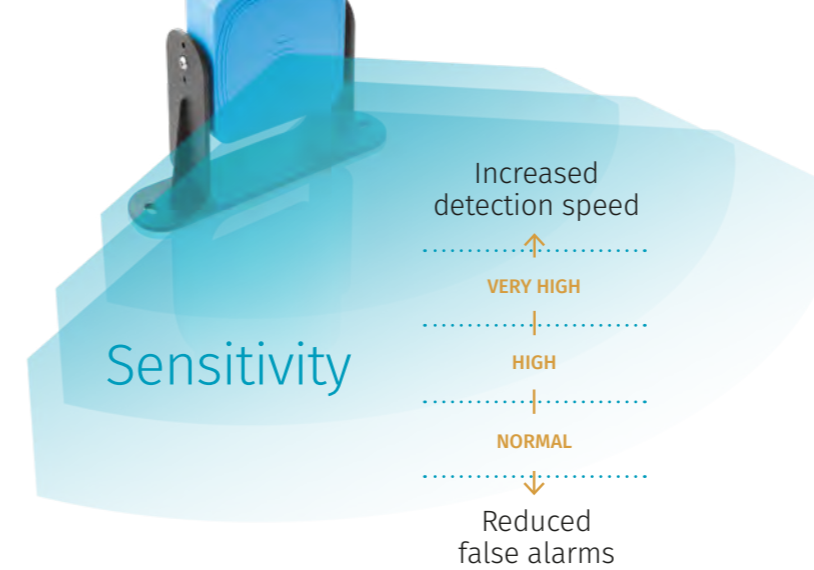

The LBK System offers three certified sensitivity levels: NORMAL - HIGH - VERY HIGH.

The NORMAL level applied to the **Detection Function** reduces the number of false alarms, filtering small objects, machine shavings, smoke, water or oil droplets, vapours and other environmental factors.

The VERY HIGH LEVEL applied to the **Restart Function** makes the system sensitive enough to detect the micro-movements of the ribcage in the act of breathing, thus preventing accidental restarts in the presence of operators.

A **pre-alarm** area can be configured: motion in the pre-alarm area will cause the closing of the dedicated auxiliary output relay. For example, this is useful for driving a light or an acoustic signal, or to signal the machinery to begin a soft stop procedure.

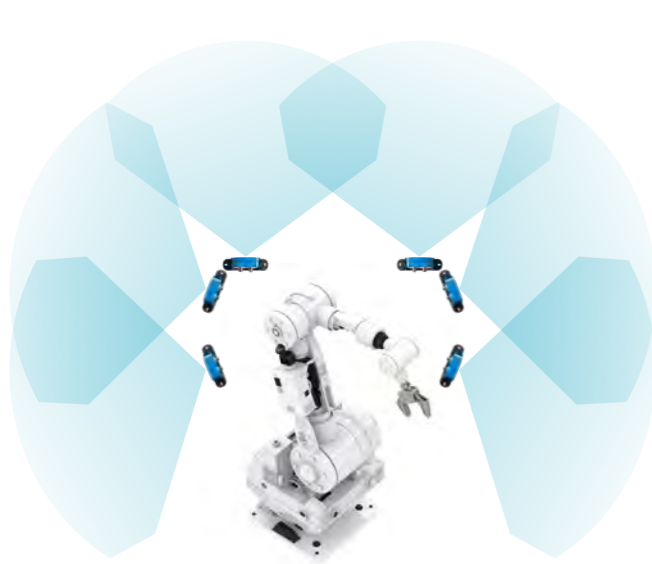

EXAMPLE 1: THREE SIDES OUT OF FOUR.

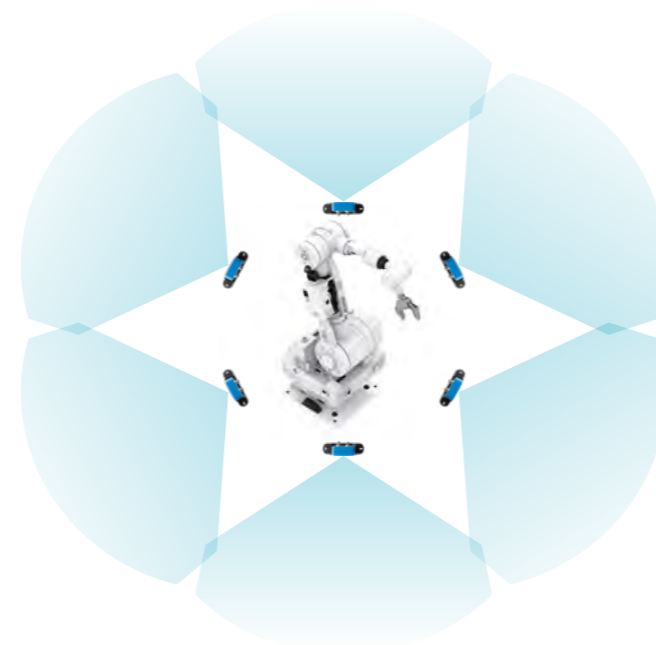

EXAMPLE 2: 360 DEGREES COVERAGE.

EXAMPLE 1
Safety on automated machine tools

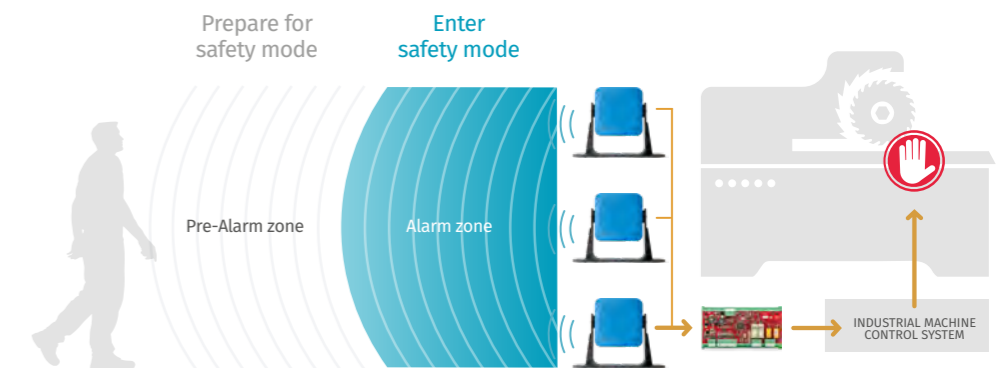

EXAMPLE 2
Safety on automated robot arm

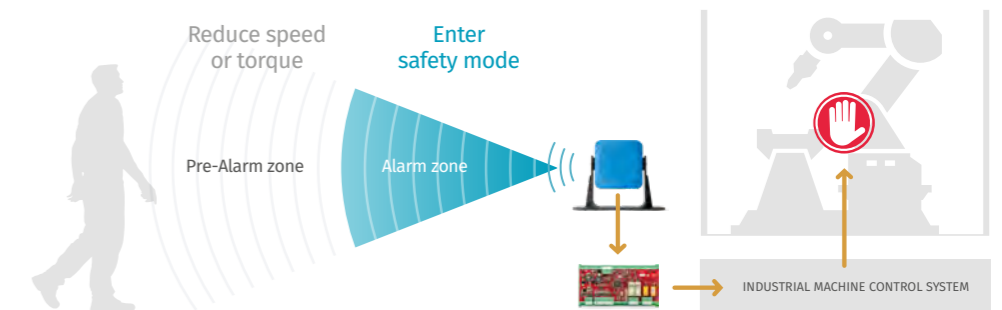

LBK-S01

The smart radar sensor

The **LBK-S01** sensor is a smart FMCW (Frequency Modulated Continuous Wave) radar device based on proprietary Inxpect detection algorithms. The sensor sends 24GHz radio waves and recovers motion information, analyzing the returned signals reflected by both static and moving objects in the operative range.

The sensors perform the following primary functions:

- **Motion and scenario analysis.**
- **Communication via CAN bus to the controller of the motion detection signal.**
- **Fault reporting and communication of diagnostic information via CAN bus to the controller.**

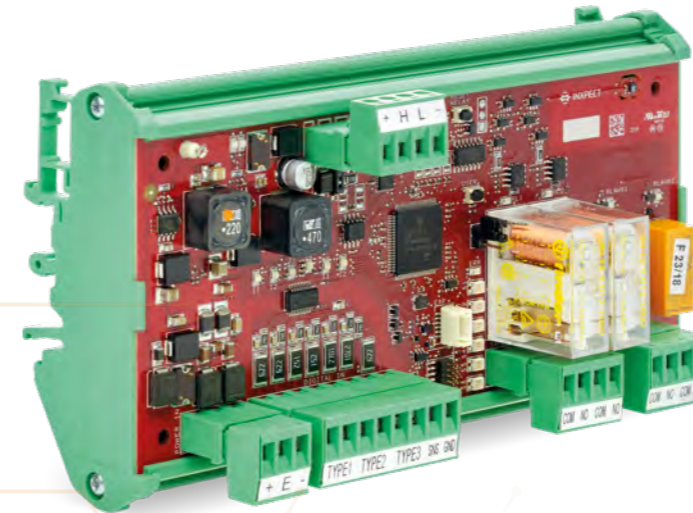
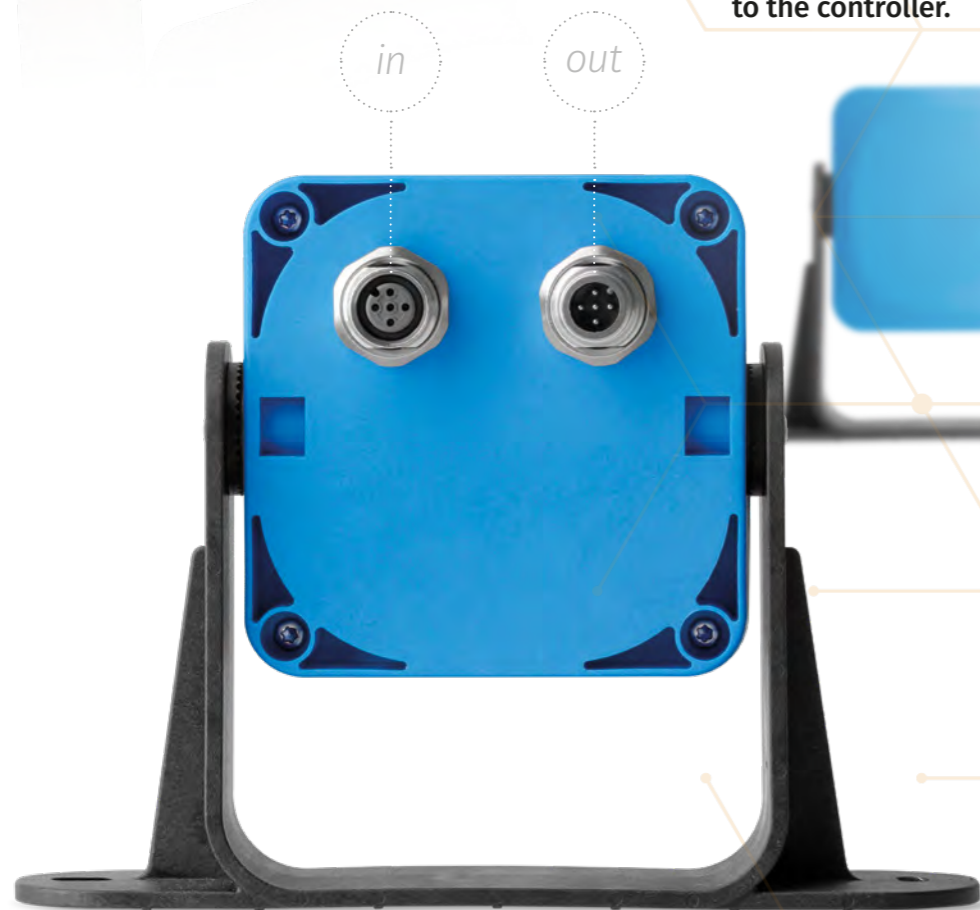

LBK-C22

The control unit

The **Inxpect LBK-C22** is the system control unit. It can connect up to six LBK-S01 smart sensors. Intervention of any single sensor results in the deactivation of the controller's safety output. The LBK-C22 control unit is configured with the Inxpect Safety PC application, which allows the configuration of sensitivity levels, safety functions, size of warning and dangerous areas, and the functionality of the controller's I/O ports.

Digital inputs

The controller has three dual-channel digital inputs and common reference potential for:

- muting (high logic level (1) = muting enabled)
- machinery emergency button (low logic level (0) = stopping enabled)
- machinery restart button enabled (high logic level (1) = restart enabled)

The digital inputs can be configured through the Inxpect Safety application software.

Auxiliary outputs

The controller has two auxiliary relay outputs, which can be configured to signal pre-alarm, fault and muting status.

Safety outputs

The controller has one dual-channel, force-guided safety relay output for alarms and direct or indirect safety of the machinery.

Dimensions

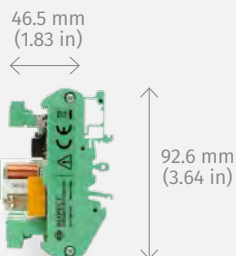
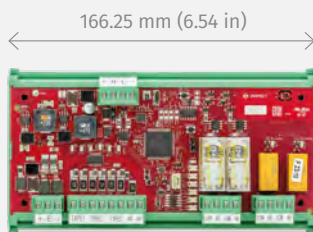
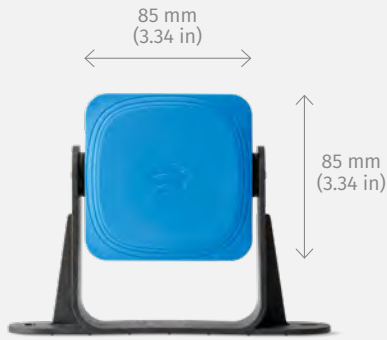

General

Detection method	Inspect motion detection algorithm based on FMCW radar
Frequency	Working band: 24–24,25 GHz (24.05–24.25 for UK and FR) Transmission power: ≤ 13 dBm - Modulation: FMCW
Detection interval	From 1 to 4 m (3.3 to 13.1 ft), depending on the installation conditions
Field of vision	Sensor horizontal plane: 110° - Sensor vertical plane: 30° Height: from 0 to 1 m (0 to 3.3 ft) - Inclination: from -20° to $+20^\circ$
Guaranteed response time	< 100 ms
SIL (Safety Integrity Level)	2
PL (Performance Level)	d
Category	2 (3 for the outputs)
Total consumption	11 W (controller and six sensors)
Operating Temperature	From -40 to $+60$ °C (-40 to $+140$ °F)
Storage Temperature	From -40 to $+80$ °C (-40 to $+176$ °F)
Communication protocol (sensors-controller)	CAN complies with standard EN 50325-5

Sensor

Connectors	2 5-pin M12 connectors (1 male and 1 female)
CAN bus termination resistance	120 Ω (not supplied, to be installed with termination connector)
Power supply	12 V dc $\pm 20\%$, through controller
Degree of protection	IP67
Material	Sensor: PA66 Bracket: PA66 and glass fiber (GF)

Controller

Outputs	4 relay outputs: 1 dual channel safety output 2 auxiliary outputs
Safety relay outputs	Forced guided relays Max voltage: 30Vdc Max current: 8Adc Max power: 240W
Auxiliary relay outputs	Electromechanical relays Max voltage: 220Vdc Max current: 2Adc Max power: 60W
Inputs	3 dual channel digital inputs with common GND: 1 type 1 1 type 2 1 type 3
Power supply	24 Vdc (20–28 Vdc) Max current: 0.6A
Consumption	Max 3.8W
Assembly	DIN guide
Degree of protection	IP20
Terminals	Section: 2.5mm ² Max Current: 12A with 2.5mm ² cables

CAN bus cables

Section	2 x 0.34mm ² power supply - 2 x 0.34mm ² data
Type	Two twisted pairs: power supply and data
Connectors	5-pole M12
Impedance	120 $\Omega \pm 12$ Ω (f = 1 MHz)
Shield	Shield with twisted wires in tin-plated copper. Requires ground connection.
Length	30m (98.4ft) from controller to sensor (configuration with 1 sensor)