

PROVIDING SAFETY

WIR SCHÜTZEN
Ihr Wertvollstes Kapital
IHRE MITARBEITER



T +49 211 88231735
www.usp-safety.com

tGard Configuration Tool

Also available on our website www.fortressinterlocks.com as an online configurator

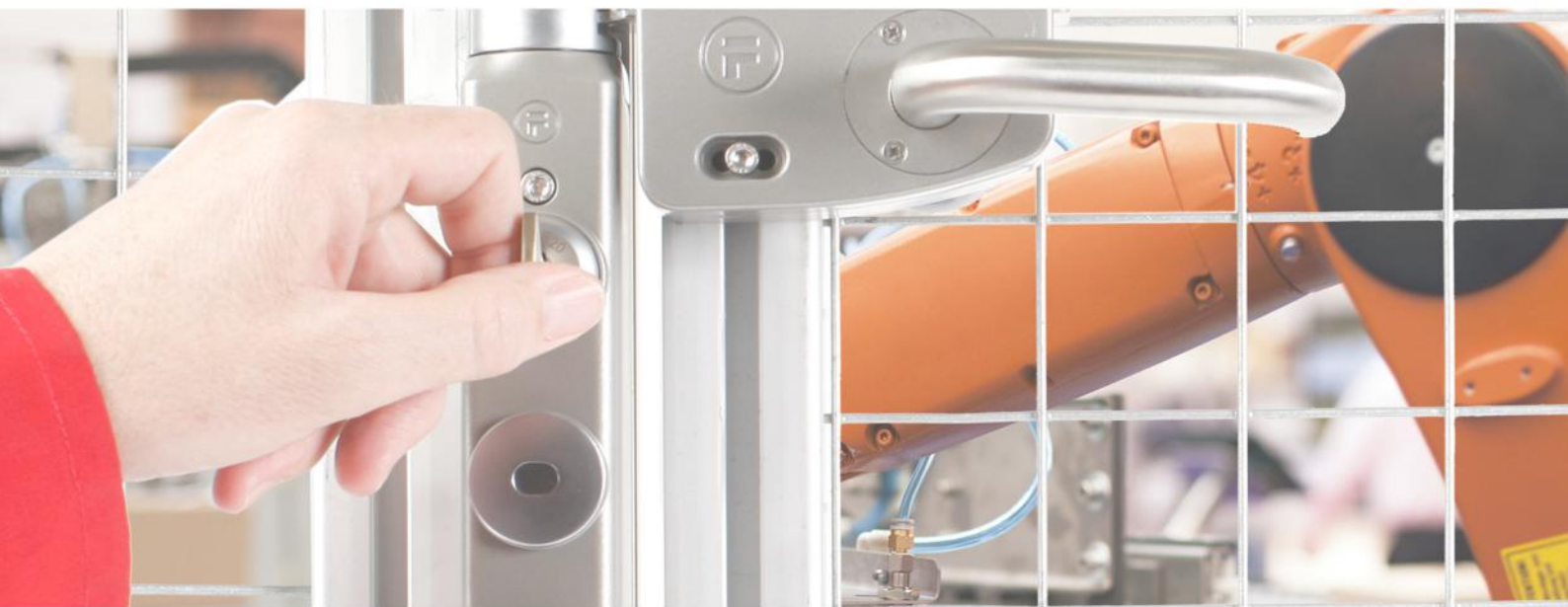

LEARN MORE

Step 1: Choose the Actuators



TAF		TAH		TAS		THB		TEN		TEH	
											
Part No.	Part No.	Part No.	Part No.	Part No.	Part No.	Part No.	Part No.	Part No.	Part No.	Part No.	Part No.
Description	Description	Description	Description	Description	Description	Description	Description	Description	Description	Description	Description
Fixed Actuator	Handle Actuator - Hinged Door	Handle Actuator - Sliding Door	Blank Handle	Handle Actuator - (no internal knob)	Handle Actuator	Handle Actuator	Blank Handle	Handle Actuator - (no internal knob)	Handle Actuator	Handle Actuator	Handle Actuator
Features & Benefits		Features & Benefits		Features & Benefits		Features & Benefits		Features & Benefits		Features & Benefits	
<ul style="list-style-type: none"> • Fixed Actuator suitable for mounting on either sliding or hinged doors. • Padlock through tongue. • 2500N Retention force. 		<ul style="list-style-type: none"> • Handle actuators suitable for bracketless mounting to hinged doors. • 4mm misalignment feature. • TAH actuator can be converted to a TAS actuator on site (special tool required). • Padlock through tongue. • 2500N Retention force. • Quick bolt to Aluminium extrude (no brackets). 		<ul style="list-style-type: none"> • Handle actuators suitable for bracketless mounting to sliding doors. • 4mm misalignment feature. • TAS actuator can be converted to a TAH actuator on site (special tool required). • Padlock through tongue. • 2500N Retention force. • Quick bolt to Aluminium extrude (no brackets). 		<ul style="list-style-type: none"> • Blank Handle (without actuator) for use on inside of doors. 		<ul style="list-style-type: none"> • Intuitive handle actuator giving latching feature on hinged doors. • 4mm misalignment feature. • Lock out feature. • Handling can be changed on site. • Prevents force of door slamming against interlock. • 2500N Retention force. • Quick bolt to Aluminium extrude. 		<ul style="list-style-type: none"> • Intuitive handle actuator giving latching feature on hinged doors. • 4mm misalignment feature. • Lock out feature. • Handling can be changed on site. • Prevents force of door slamming against interlock. • 2500N Retention force. • Quick bolt to Aluminium extrude. • Internal knob allows actuator to be retracted but not extended. 	

Actuators



ti

Note: The internal knob on TEH handle does not override the solenoid or lock. A TRXZ (internal release element) must be used to deliver that functionality.

ti





All Actuators to be used in combination with a THM head module.

Head Modules



THC		THM	
			
Part No.	THC	Part No.	THM
Description	Cap Element	Description	Actuator Head Element
Features & Benefits		Features & Benefits	
<ul style="list-style-type: none"> Used to terminate all non door lock or gate switch configurations. Used in mechanical exchange box, machine control or key switch configurations. 		<ul style="list-style-type: none"> Ideally suited for authorised access only, or linked access to other machinery. 5 orientations (left, right, front, back and top). Can be used to lock door when used with keys or solenoid or just as driver for safety switches. Rotatable through 90° (remove screws). 2500N retention force. Metal construction with no extra fixing required. 	

ti

You can combine a actuator with a head to generate a single part number



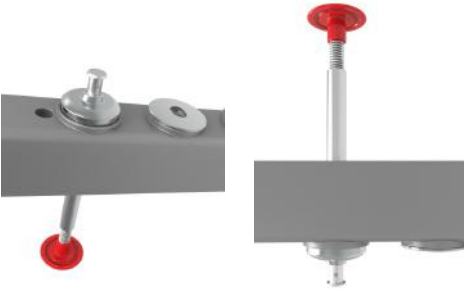

Head + Actuator Combined Part Number Options									
THF		THH		THS		THE		THN	
									
Part No.	THM + TAF = THF	Part No.	THM + TAH = THH	Part No.	THM + TAS = THS	Part No.	THM + TEH = THE	Part No.	THM + TEN = THN
Description	Head module including fixed actuator	Description	Head module including hinged actuator	Description	Head module including sliding actuator	Description	Head module including handle actuator	Description	Head module including handle actuator (no internal knob)

Core Elements

TRX	TRZ
	
Part No. Description	Part No. Description
Standard 60mm Internal Release	Variable length Internal Release
Features & Benefits	
<ul style="list-style-type: none"> • Element allows emergency exit even if unit is locked by keys and or solenoid. • Unit automatically breaks safety circuits and holds them open until unit is reset. • When present, the push IR always occupies the top element. • TRX works through wall thickness upto 60mm. • TRZ allows customer to customise length of emergency release. • Post should be supported if not going through aluminum extrude. 	





Step 4: Safety & Access Lock Element

TSN		TGN		TAB		TQB	
							
Part No.	TSN	TGN	TGN	Part No.	TAB	TQB	TQB
Description	Standard Safety Lock (no key)*	Master Safety Lock (no key)*	Master Safety Lock (no key)*	Description	Standard Access Lock (no key)*	Master Access Lock (no key)*	Master Access Lock (no key)*
Features & Benefits		Features & Benefits		Features & Benefits			
<ul style="list-style-type: none"> • Prevent closure of door and start up until key returned. • Safety Lock must be directly under head / cap (or under internal release element if one is fitted). • Robust radial disc tumbler lock. • >3000 combinations. • 10 mastered combinations (can be used with all 3000 individual combinations). • The key is laser marked with the Fortress key code. • No key included. *Keys Ordered Separately. • Max. No. of mechanical locks = 10. 		<ul style="list-style-type: none"> • Prevent closure of door and start up until key returned. • Safety Lock must be directly under head / cap (or under internal release element if one is fitted). • Robust radial disc tumbler lock. • >3000 combinations. • 10 mastered combinations (can be used with all 3000 individual combinations). • The key is laser marked with the Fortress key code. • No key included. *Keys Ordered Separately. • Max. No. of mechanical locks = 10. 		<ul style="list-style-type: none"> • Only allow access with correct key. • Access keys must be directly under safety locks (or under head or internal release if no safety locks). • Robust radial disc tumbler lock. • >3000 combinations. • 10 mastered combinations (can be used with all 3000 individual combinations). • The key is laser marked with the Fortress key code. • No key included. *Keys Ordered Separately. • Max. No. of mechanical locks = 10. 			



Core Elements



TSM / TSP		TSS	
			
Part No.	TSM / TSP	Part No.	TSS
Description	Safety Switch	Description	Safety Switch - No N/O monitor contact
Features & Benefits		Features & Benefits	
<ul style="list-style-type: none"> • Can be driven by either the operation of the head element (removal of actuator) or a mechanical lock. • Operates on dual safety circuits. • 2 positively driven force break NC contacts (uses none of the I/O pins). • IP65. • 1 Normally Open (N/O) contact giving 24V signal on I/O pin. • Red LED illumination to show door open. • First element after all mechanical elements (Head, Internal Release and Locks). • Extra retention force available (TSP). 		<ul style="list-style-type: none"> • Can be driven by either the operation of the head element (removal of actuator) or a mechanical lock. • Operates on dual safety circuits. • 2 positively driven force break NC contacts (uses none of the I/O pins). • IP65. • First element after all mechanical elements (Head, Internal Release and Locks). • No monitor contact & no LED. • Uses 4 pins for safety circuits (no power required). *Works with TQ1 (5 Pin QD). 	
Number of Safety Circuits		Number of Safety Circuits	
2		2	
Number of Control I/O		Number of Control I/O	
1		0	



Step 6: Solenoid Controlled Lock & Safety Switch Elements - Power to Un-Lock / Power to Lock



Core Elements

TSMDU/L	TSMEU/L	TSMFU/L	TSSEU/L	
	 <p>Power to Un-lock</p> <ul style="list-style-type: none"> • 1 input used to energise solenoid. • Power to Lock and Power to Unlock options available. • Solenoid override key provided with power to unlock units. • First element after all mechanical elements (Head, Internal Release and Locks). 	 <p>Power to Lock</p>		
Part No.	TSMDU / TSMDL	TSMEU / TSMEI	TSMFU / TSMFL	TSSEU / TSSEL
Description	Head & solenoid safety in series TSMDU (Power to Un-lock) TSMDL (Power to Lock) • 2500N retention force. • 2 X Normally closed safety circuits run through head safety switches and solenoid safety switches. • Non safety monitor circuit on head gives 24V when door opened. • Non safety monitor circuit on solenoid gives 24V when unlocked.	Safety on head element only TSMEU (Power to Un-lock) TSMEI (Power to Lock) • 2500N retention force. • 2 X Normally closed safety contacts driven by head only (not solenoid). • Non safety monitor circuit on head gives 24V when door opened. • Non safety monitor circuit on solenoid gives 24V when locked.	Four safety circuits TSMFU (Power to Un-lock) TSMFL (Power to Lock) • 2500N retention force. • Four safety circuits - 2 independent NC circuits for the head and 2 independent NC circuits for the solenoid. • Non safety monitor circuit on head gives 24V when door opened. • Non safety monitor circuit on solenoid gives 24V when unlocked.	Safety on head element only (no monitoring contact on head) TSSEU (Power to Un-lock) TSSEL (Power to Lock) • 2500N retention force. • 2 X Normally closed safety contacts driven by head only (not solenoid). • Non safety monitor circuit on solenoid gives 24V when locked.
Features & Benefits	• LED sequence: *Green = Door closed & locked *Green & Red = Door closed but unlocked *Red = Door open	• LED sequence: *Green = Door closed & locked *Green & Red = Door closed but unlocked *Red = Door open	• LED sequence: *Green = Door closed & locked *Green & Red = Door closed but unlocked *Red = Door open	• LED sequence: *Nothing = Door closed & locked *Red = Door unlocked
Number of Safety Circuits	2	2	4	2
Number of Control I/O	3	3	3	2

ti
90% of customers select TSMDU

ti
Location of safety switch in stack is first element after all mechanical elements (Head, Internal Release and Locks).

TEB	
	
Part No.	TEB
Description	Extension Blank Element
Features & Benefits	<p>Can be driven by either the operation of the head element (removal of actuator) or a mechanical lock.</p> <p>Can be used to add extension bay to a configuration.</p>

TEC, TED, TEW, TEV, TET, TEM, TEP, TEI









Features & Benefits

- Emergency stop element, version available with a monitoring contact or illumination.
- 2 positively driven force break N/C Safety contacts.
- Monitored version also has 1 output signal and this uses 1 output pin.
- Illuminated version also has 1 input signal and this uses 1 input pin (it is illuminated by the controlling PLC, not by the action of pressing the e-stop).
- e-Stop is always mounted at the top of any control elements, but below solenoid / head / safety switches / locks.
- TEM & TEI e-stops can also be positioned at the bottom of the stack.
- TED/C/W/V safety contacts are wired in series with another element in the stack e.g. TSS, to reduce pin requirements.
- TET/M/P/I safety contacts are wired separately to all other elements in the stack.

Part No.	TEC	TEW	TED	TEV	TET	TEP	TEM	TEI
Reset Type	Twist	Pull	Twist	Twist	Twist	Pull	Twist	Twist
Extra Features	-	-	Additional 1xNO Contact	Illuminated	-	-	Additional 1xNO Contact	Illuminated
Number of Control I/O	0	0	1	1	0	0	1	1
Number of Safety Circuits	0 - wired in series with TSS or TSM unit 2 - independently wired							



Step 9: Start Re-Start Switch

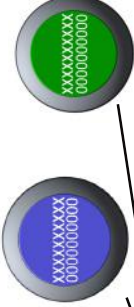























TSR		TS3		TSK	
					
Part No.	TSR	TS3	TSK	TSK	TSK
Description	Start Re-start Switch - Blue	Start Re-start Switch - Green	Start Re-start Switch - Black Mushroom	Start Re-start Switch - Black Mushroom	Start Re-start Switch - Black Mushroom
Features & Benefits	<ul style="list-style-type: none"> • TSR (Blue), TS3 (Green) & TSK (Black Mushroom) Re-start switch operating on 1 Normally Open (N/O) and 1 Normally Closed (N/C). • For Safety relay reset. • Works on own separate dual safety circuit. • Volt free contacts. • Safety circuit 1 opens on button depression. • Highest control element after e-Stop's. • Must be wired independently to all other safety switches (head / solenoid / e-stop). 				
Number of Control I/O	<p>Laser Engraving Information: Engraving for each button is 2 lines of 10 characters.</p> 				
Number of Safety Circuits	<p>0</p> <p>2</p>				































Step 10: Blue Independently Wired Switch & Potentiometer















TSZ	
Part No.	TSZ
Description	Blue Independently Wired Change Over Switch
Features & Benefits	<ul style="list-style-type: none"> • Blue Independently Wired Change Over Switch operating on 1 Normally Open (N/O) and 1 Normal Closed (N/C). • For safety relay / safety PLC connection • Works on own separate supply. <div style="text-align: right;"> <p>Laser Engraving Information: Engraving for each button is 2 lines of 10 characters.</p> </div>
Number of Control I/O	3
Number of Safety Circuits	0

TV4	
Part No.	TV4
Description	Potentiometer 10K
Features & Benefits	<ul style="list-style-type: none"> • Common uses include speed control for variable frequency drives. • No centre detent. • Inputs to tGard are always assigned before outputs.
Number of Control I/O	3
Number of Safety Circuits	0





	TP1 		TP2 		TP3 		TP6 		TP7 	
	Part No.	Description	Part No.	Description	Part No.	Description	Part No.	Description	Part No.	Description
	TP1	Illuminated Push Button - Red	TP2	Illuminated Push Button - Yellow	TP3	Illuminated Push Button - Green	TP6	Illuminated Push Button - Blue	TP7	Illuminated Push Button - White
	TG1 		TG3 		TG5 		TG6 		TG7 	
	Part No.	Description	Part No.	Description	Part No.	Description	Part No.	Description	Part No.	Description
	TG1	Protruding Illuminated Push Button - Red	TG3	Protruding Illuminated Push Button - Green	TG5	Protruding Illuminated Push Button - Yellow	TG6	Protruding Illuminated Push Button - Blue	TG7	Protruding Illuminated Push Button - White
	TJ1 		TJ2 		TJ3 		TJ6 		TJ7 	
	Part No.	Description	Part No.	Description	Part No.	Description	Part No.	Description	Part No.	Description
	TJ1	1 N/O Illuminated Push Button (Latching) - Red	TJ2	1 N/O Illuminated Push Button (Latching) - Yellow	TJ3	1 N/O Illuminated Push Button (Latching) - Green	TJ6	1 N/O Illuminated Push Button (Latching) - Blue	TJ7	1 N/O Illuminated Push Button (Latching) - White
	TX1 		TX2 		TX3 		TX6 		TX7 	
	Part No.	Description	Part No.	Description	Part No.	Description	Part No.	Description	Part No.	Description
	TX1	1 N/O & 1 N/C Illuminated Push Button - Red	TX2	1 N/O & 1 N/C Illuminated Push Button - Yellow	TX3	1 N/O & 1 N/C Illuminated Push Button - Green	TX6	1 N/O & 1 N/C Illuminated Push Button - Blue	TX7	1 N/O & 1 N/C Illuminated Push Button - White

Volt Free Contacts Illuminated Pushbuttons		TU1		TU2		TU3		TU6		TU7					
Part No.	Description	Part No.	Description	Part No.	Description	Part No.	Description	Part No.	Description	Part No.	Description				
	Volt Free Contacts Illuminated Push Button - Red	TU1	Volt Free Contacts Illuminated Push Button - Red		TU2	Volt Free Contacts Illuminated Push Button - Yellow		TU3	Volt Free Contacts Illuminated Push Button - Green		TU6	Volt Free Contacts Illuminated Push Button - Blue		TU7	Volt Free Contacts Illuminated Push Button - White
2 Position Illuminated Selector Switch		T2E		T2F		T2E		T2E		T2E		T2E		T2E	
															
Part No.	Description	Part No.	Description	Part No.	Description	Part No.	Description	Part No.	Description	Part No.	Description	Part No.	Description	Part No.	Description
	2 Position Illuminated Selector Switch Latching	T2E	2 Position Illuminated Selector Switch - Latching		2 Position Illuminated Selector Switch Momentary	T2F	2 Position Illuminated Selector Switch - Momentary								
<p>Features & Benefits</p> <ul style="list-style-type: none"> 1 Normally Open (N/O) Illuminated Switch for machine control. Each switch uses 1 input and 1 output pin. Inputs to the tGard stack are always assigned before outputs. High input will illuminate the lamp, irrespective of selector. <p>Range of options:</p> <ul style="list-style-type: none"> Push Button Protruding Push Button 2 Position Selector Switches <ul style="list-style-type: none"> Latching Momentary <p>Laser Engraving Information: Engraving for each button is 2 lines of 10 characters.</p> <p>Engraving available for 2 position selector switch is 10 characters at each switch position.</p>															

 1 N/O Non-Illuminated Pushbuttons	 TPB		 TPR		 TPG		 TPW		 TPY		 TPZ	
	Part No. Description	TPB 1 N/O Non-Illuminated Push Button - Black	Part No. Description	TPR 1 N/O Non-Illuminated Push Button - Red	Part No. Description	TPG 1 N/O Non-Illuminated Push Button - Green	Part No. Description	TPW 1 N/O Non-Illuminated Push Button - White	Part No. Description	TPY 1 N/O Non-Illuminated Push Button - Yellow	Part No. Description	TPZ 1 N/O Non-Illuminated Push Button - Blue
 1 N/O Non-Illuminated Pushbuttons - Protruding	 TGB		 TGR		 TGG		 TGW		 TGY		 TGZ	
	Part No. Description	TGB Protruding 1 N/O Non-Illuminated Push Button - Black	Part No. Description	TGR Protruding 1 N/O Non-Illuminated Push Button - Red	Part No. Description	TGG Protruding 1 N/O Non-Illuminated Push Button - Green	Part No. Description	TGW Protruding 1 N/O Non-Illuminated Push Button - White	Part No. Description	TGY Protruding 1 N/O Non-Illuminated Push Button - Yellow	Part No. Description	TGZ Protruding 1 N/O Non-Illuminated Push Button - Blue
 1 N/O & 1 N/C Illuminated Pushbuttons	 TXB		 TXR		 TXG		 TXW		 TXY		 TXZ	
	Part No. Description	TXB 1 N/O & 1 N/C Non-Illuminated Push Button - Black	Part No. Description	TXR 1 N/O & 1 N/C Non-Illuminated Push Button - Red	Part No. Description	TXG 1 N/O & 1 N/C Non-Illuminated Push Button - Green	Part No. Description	TXW 1 N/O & 1 N/C Non-Illuminated Push Button - White	Part No. Description	TXY 1 N/O & 1 N/C Non-Illuminated Push Button - Yellow	Part No. Description	TXZ 1 N/O & 1 N/C Non-Illuminated Push Button - Blue

Volt Free Contacts Push Buttons 	TUB 		TUR 		TUG 		TUW 		TUY 		TUZ 			
	Part No. Description	TUB Volt Free Contacts Non-Illuminated Push Button - Black	TUR Volt Free Contacts Non-Illuminated Push Button - Red	TUG Volt Free Contacts Non-Illuminated Push Button - Green	TUW Volt Free Contacts Non-Illuminated Push Button - White	TUY Volt Free Contacts Non-Illuminated Push Button - Yellow	TUZ Volt Free Contacts Non-Illuminated Push Button - Blue							
2 Position Selector Switch 	T2A 		T2D 		T2V 		2 Position Selector Key Switch							
	Part No. Description	T2A 2 Position Non-Illuminated Selector Switch - Latching	T2D 2 Position Non-Illuminated Selector Switch - Momentary	T2V 2 Position Non-Illuminated Selector Switch - 1 N/O & 1 N/C										
1 N/O Mushroom Push Button 	TMB 		1 N/O Non-Illuminated Pushbuttons - Latching 						TPS 					
	Part No. Description	TMB 1 N/O Non-Illuminated Mushroom Push Button - Black							TPS 1 N/O Non-Illuminated Push Button (Latching) - Black					
Features & Benefits														
1 N/O Switch for machine control. • Each switch uses 1 output pin. • Range of options: • Push Button • Protruding Push Button • 2 Position Selector Switches • Latching • Key Latching • Momentary • Key Momentary														
1 N/O Switch & 1 N/C Switch for machine control. • Each switch uses 2 output pin. • Contacts are not volt free. Laser Engraving Information: Engraving for each button is 2 lines of 10 characters. Engraving available for 2 position selector switch is 10 characters at each switch position.														

Core Elements

	TLB	TLG	TLR	TLW	TLY
					
Part No.	TLB	TLG	TLR	TLW	TLY
Description	LED Lamp Element - Blue	LED Lamp Element - Green	LED Lamp Element - Red	LED Lamp Element - White	LED Lamp Element - Yellow

Features & Benefits

Lamp element for status indication can be configured to indicate machine status.

- LED status indicator.
- Each lamp uses 1 input pin.

Laser Engraving Information:

Engraving for each lamp is 2 lines of 10 characters.



T3A, T3D, T3E, T3F, T3H, TK7						
Part No.	T3A	T3D	T3E	T3F	T3H	TK7
Description	Latching (Both Sides)	Momentary	Latching (Both Sides) Illuminated	Momentary Illuminated	Momentary / Latching	Key Latching (Both Sides)
Features & Benefits						
<p>Each 3 position selector switch uses 2 output pins.</p> <ul style="list-style-type: none"> • Clockwise operation sets the lower assigned output High. • Middle position - output pins Low. • Anti-clockwise sets higher assigned output High. • Non-latching - spring return to original position. • Illumination (when selected) uses an additional 1 input pin. <p>Laser Engraving Information: Engraving available for 3 position selector switch is 10 characters at each switch position.</p>						

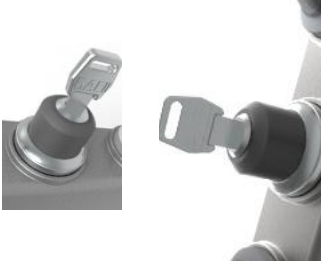

Step 15: Foot, Safety & Control Connectors



Base Elements		TBF	TQ1	TQ2	TQ3	TQ4
						
Part No.	TBF	TQ1	TQ2	TQ3	TQ4	
Description	Foot - For terminating purely mechanical configurations (no wiring).	5 Pin M12 QD	8 Pin M12 QD	8 Pin M12 QD	12 Pin M23 QD	
Number of Control I/O	0	0	5	1	9	
Number of Safety Circuits	0	2	0	2	0	
	TQ5	TQ7	TQ8	TQ9		
						
Part No.	TQ5	TQ7	TQ8	TQ9		
Description	12 Pin M23 QD	14 Pin 7/8" UN2 QD	19 Pin M23 QD	19 Pin M23 QD		
Number of Control I/O	5	7	12	8		
Number of Safety Circuits	2	2	2	4		

Step 16: Mating Cables for Quick Disconnect Connectors





Base Elements

Quick Disconnect Mating Cable				Cable_M-TQ2 / TQ3				Cable_M-TQ4 / TQ5				Cable_M-TQ7				Cable_M-TQ8 / TQ9			
Part No.	Cable_M-TQ1																		
No. Pins	5																		
Connector	M12																		
Pin#	Wire Colour	Function	Wire Colour	Function	Wire Colour	Function	Wire Colour	Function	Wire Colour	Function	Wire Colour	Function	Wire Colour	Function	Wire Colour	Function	Wire Colour	Function	
1	Brown	SC1 in	White	I/O 0	Brown	+24v	Grey / Pink	I/O 3	Violet	SC1 in	Blue	I/O 3	Yellow	SC1 in	White	SC1 in	White	SC1 in	
2	White	SC2 in	Brown	+24v	Brown/ White	I/O 0	White / Green	I/O 2	Red	SC2 in	White / Yellow	I/O 2	Brown / Yellow	SC2 in	Red	SC2 in	Red	SC2 in	
3	Blue	SC1 out	Green	Earth	Blue	0v	White / Yellow	I/O 1	Grey	SC1 out	White / Yellow	I/O 1	Brown / Yellow	SC1 out	Grey	SC1 out	Grey	SC1 out	
4	Black	SC2 out	Yellow	I/O 1	White	I/O 1	Brown	+24v	Red/ Blue	SC2 out	Brown	+24v	Brown / Yellow	SC2 in	Red/ Blue	SC2 out	Red/ Blue	SC2 out	
5	Grey	Earth	Grey	I/O 2	Green	I/O 2	Green	SC2 in	Green	I/O 0	Green	SC2 in	Blue	0v	Green	I/O 0	Green	I/O 0	
6			Pink	I/O 3	Yellow	I/O 3	Blue	0v	Blue	0v	Blue	0v	Blue	0v	Blue	0v	Blue	0v	
7			Blue	0v	Grey	I/O 4	Yellow	I/O 6	Yellow	I/O 1	Yellow	I/O 6	Yellow	I/O 1	Grey/ Pink	I/O 1	Grey/ Pink	I/O 1	
8			Red	I/O 4	Pink	I/O 5	Green	I/O 5	Green	I/O 2	Green	I/O 5	Green	I/O 2	White/ Green	I/O 2	White/ Green	I/O 2	
9					Red	I/O 6	Pink	I/O 4	Pink	I/O 3	Pink	I/O 4	Pink	I/O 3	White/ Yellow	I/O 3	White/ Yellow	I/O 3	
10					Black	I/O 7	White	SC1 in	White	SC1 in	White	SC1 in	White	SC1 in	White/ Grey	I/O 4	White/ Grey	I/O 4	
11					Violet	I/O 8	Red / Blue	I/O 0	Red / Blue	I/O 5	Red / Blue	I/O 0	Red / Blue	I/O 5	Black	I/O 5	Black	I/O 5	
12					Green/ Yellow	Earth	Green/ Yellow	SC2 out	Brown / Green	SC2 out	Brown / Green	SC2 out	Brown / Green	SC2 out	Green/ Yellow	Earth	Green/ Yellow	Earth	
13							Grey	SC1 out	Grey	SC1 out	Grey	SC1 out	Grey	SC1 out	Yellow/ Brown	I/O 6	Yellow/ Brown	I/O 6	
14							Red	Earth	Red	Earth	Red	Earth	Red	Earth	Brown/ Green	I/O 7	Brown/ Green	I/O 7	
15															White	I/O 8	White	I/O 8	
16															Yellow	I/O 9	Yellow	I/O 9	
17															Pink	I/O 10	Pink	I/O 10	
18															Grey/ Brown	I/O 11	Grey/ Brown	I/O 11	
19															Brown	+24v	Brown	+24v	

Part No.	Pin Heads	Connector Type	Cable Length	Cable Part Number
Cable_M-TQ1		TQ1	2M	Cable-2M-TQ1
			5M	Cable-5M-TQ1
			10M	Cable-10M-TQ1
			20M	Cable-20M-TQ1
			2M	Cable-2M-TQ2
Cable_M-TQ2 / TQ3		TQ2	5M	Cable-5M-TQ2
			10M	Cable-10M-TQ2
			20M	Cable-20M-TQ2
			2M	Cable-2M-TQ3
			5M	Cable-5M-TQ3
Cable_M-TQ4 / TQ5		TQ3	10M	Cable-10M-TQ3
			20M	Cable-20M-TQ3
			2M	Cable-2M-TQ4
			5M	Cable-5M-TQ4
			10M	Cable-10M-TQ4
Cable_M-TQ7		TQ4	20M	Cable-20M-TQ4
			2M	Cable-2M-TQ5
			5M	Cable-5M-TQ5
			10M	Cable-10M-TQ5
			20M	Cable-20M-TQ5
Cable_M-TQ8 / TQ9		TQ5	2M	Cable-2M-TQ7
			5M	Cable-5M-TQ7
			10M	Cable-10M-TQ7
			20M	Cable-20M-TQ7
			2M	Cable-2M-TQ8
Cable_M-TQ8 / TQ9		TQ7	5M	Cable-5M-TQ8
			10M	Cable-10M-TQ8
			20M	Cable-20M-TQ8
			2M	Cable-2M-TQ9
			5M	Cable-5M-TQ9
Cable_M-TQ8 / TQ9		TQ8	10M	Cable-10M-TQ9
			20M	Cable-20M-TQ9
			2M	Cable-2M-TQ9
			5M	Cable-5M-TQ9
			10M	Cable-10M-TQ9
Cable_M-TQ8 / TQ9		TQ9	20M	Cable-20M-TQ9

Base Elements

	TW1	TW3	TW4
			
Part No.	TW1	TW3	TW4
Description	12 Terminals	24 Terminals	24 Terminals
Number of Control I/O	6	14	10
Number of Safety Circuits	2	4	6
Features & Benefits			
<ul style="list-style-type: none"> • For applications where the customer wishes to make their own connections. • Push fit terminals. • Cable size 26-14 AWG. • Available with 12 or 24 connections. • Control only and Safety and Control versions available. • M20 gland thread. • Requires no additional mounting to frame. • Large opening for easy wiring. 			

Base Elements

	<p>TEBB4</p>  	<p>TEBB8</p>
<p>Part No.</p>	<p>TEBB4</p>	<p>TEBB8</p>
<p>Description</p>	<p>Up to 2 AS-i nodes</p>	<p>Up to 4 AS-i nodes</p>
<p>Number of Control I/O</p>	<p>Up to 4 inputs, 4 outputs</p>	<p>Up to 8 inputs, 8 outputs</p>
<p>Number of Safety Circuits</p>	<p>1 dual safety circuit</p>	<p>2 dual safety circuits</p>
<p>Features & Benefits</p>		
<ul style="list-style-type: none"> • AS-interface base elements are used when you want to connect all of the features of tGard to an AS-i-bus. • TEBB4 Element - Connect up to 4 inputs, 4 outputs and 1 dual channel safety circuit to the bus in one stack. • TEBB8 Element - Connect up to 8 inputs, 8 outputs and 2 dual channel safety circuits to the bus in one stack. • Each node address can handle either 4 inputs and 4 outputs, or 1 dual channel safety circuits; you only get the nodes you need to maximise available bus addresses. • Extended addressing is used for the I/O nodes allowing 62 nodes on a bus; double the number possible on a standard bus. • Connections are made by the standard M12 5 pin QD. • Mating cables are available, part no. Cable-_M-TQ1;2.5,10 and 20m lengths. • Most elements are powered directly from the bus meaning only two wires are necessary to run the whole stack; the Aux power supply is required if a solenoid lock is included in the stack. • The element takes one bay to house the AS-i electronics and includes the base connection element. 		

Step 19: Accessories

TKS	TKM
Part No.	TKS Standard Key
Description	TKM Master Key
Features & Benefits	
<ul style="list-style-type: none"> • Torque rating 10Nm. • High corrosive resistance. • Over 5,000 non-masterable combinations available. • 10 masterable combinations available. • The key is laser marked with the Fortress key code. 	

TWA, TWB, TWC, TWD, TWE, TWF, TWG, TWH			
 TWA	 TWC	 TWB	 TWD
 TWE	 TWG	 TWF	 TWH
Part No.	TWA, TWB, TWC, TWD, TWE, TWF, TWG, TWH		
Description	White Legend Plate		
Features & Benefits			
<ul style="list-style-type: none"> • For marking of control elements. • Mechanically fixed using M3 screws. • Can be mounted above or below control element (Note: When marking in the top orientation the first bay is unable to be marked). • Laser marked. • TWA, TWC, TWE & TWG- 2 lines of 10 characters. • TWB, TWD, TWF & TWH - 2 lines of 5 characters • Text can be marked upside down. • Legend plate requirement must be specified at point of ordering a tGard configuration, otherwise housing will not be drilled to accept legend plate. 			

Protecting People, Industry and Productivity

A HALMA COMPANY



Official Distributor

Fortress Interlocks Ltd
☎ +44 (0)1902 349000
☎ +44 (0)1902 349090
✉ sales@fortressinterlocks.com

Fortress Interlocks Europe
☎ +31 (0)10 7536060
☎ +31 (0)10 7536050
✉ europe@fortressinterlocks.com

Fortress Interlocks USA
☎ +1 (859) 578 2390
☎ +1 (859) 341 2302
✉ us@fortressinterlocks.com

Fortress Interlocks Pty Ltd
☎ +61 (0)3 9771 5350
☎ +61 (0)3 9771 5360
✉ australia@fortressinterlocks.com

Fortress Interlocks China
☎ +86 (021) 6016 7611
✉ china@fortressinterlocks.com

www.fortressinterlocks.com